

PRODUCT FEATURES

- 650V IGBT chip in trench FS-technology
- Low switching losses
- $V_{CE(sat)}$ with positive temperature coefficient
- Fast switching and short tail current
- Free wheeling diodes with fast and soft reverse recovery

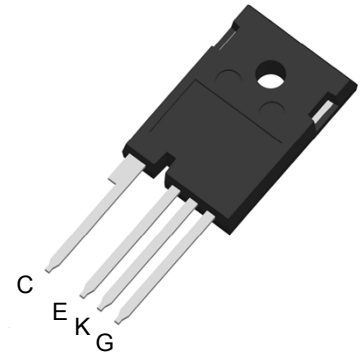

APPLICATIONS

- Motor control
- UPS/PFC
- General purpose inverters

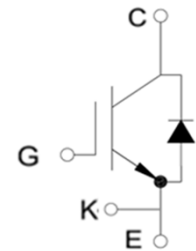

Type	V_{CES}	I_C	$V_{CE(sat)}$ $T_J=25^\circ C$	T_{Jmax}	Marking	Package
MM75G5U65BKX	650V	75A	1.7V	175°C	MM75G5U65BKX	TO-247

MacMic Science & Technology Co., Ltd.

Add: #18, Hua Shan Zhong Lu, New District, Changzhou City, Jiangsu Province, P. R. of China

Tel.: +86-519-85163708 Fax: +86-519-85162291 Post Code: 213022 Website: www.macmicst.com

MM75G5U65BKX

ABSOLUTE MAXIMUM RATINGS($T_C=25^{\circ}\text{C}$ unless otherwise specified)

Symbol	Parameter/Test Conditions		Values	Unit
V_{CES}	Collector Emitter Voltage	$T_J=25^{\circ}\text{C}$	650	V
V_{GES}	Gate Emitter Voltage		± 20	
	Transient Gate Emitter Voltage ($t_p \leq 10\mu\text{s}, D < 0.01$)		± 30	
I_C	DC Collector Current	$T_C=25^{\circ}\text{C}$	100	A
		$T_C=100^{\circ}\text{C}$	75	
I_{Cpuls}	Pulsed collector current, t_p limited by T_{Jmax}		300	
P_{tot}	Power Dissipation Per IGBT		385	W
V_{RRM}	Repetitive Reverse Voltage	$T_J=25^{\circ}\text{C}$	650	V
I_F	Forward Current	$T_C=25^{\circ}\text{C}$	100	A
		$T_C=100^{\circ}\text{C}$	75	
I_{Fpuls}	Diode pulsed current, t_p limited by T_{Jmax}		300	
T_{Jmax}	Max. Junction Temperature		175	$^{\circ}\text{C}$
T_{Jop}	Operating Temperature		-40~175	
T_{stg}	Storage Temperature		-55~150	
T_{SLD}	Wave Soldering 1.6mm (0.063in.) from case for 10s		260	
Torque	to heatsink	Recommended (M3)	1.1	Nm
Weight			8	g

THERMAL RESISTANCE($T_C=25^{\circ}\text{C}$ unless otherwise specified)

Symbol	Parameter/Test Conditions	Min.	Typ.	Max.	Unit
R_{thJC}	Junction to Case Thermal Resistance (IGBT)			0.39	K /W
R_{thJCD}	Junction to Case Thermal Resistance (Diode)			0.36	
R_{thJA}	Junction to Ambient Thermal Resistance			40	

MM75G5U65BKX

IGBT

ELECTRICAL CHARACTERISTICS ($T_C = 25^\circ\text{C}$ unless otherwise specified)

Symbol	Parameter/Test Conditions		Min.	Typ.	Max.	Unit
$V_{GE(th)}$	Gate Emitter Threshold Voltage	$V_{CE}=V_{GE}, I_C=3.0\text{mA}$	3.6	4.1	4.7	V
$V_{CE(sat)}$	Collector Emitter Saturation Voltage	$I_C=75\text{A}, V_{GE}=15\text{V}, T_J=25^\circ\text{C}$		1.65	2.1	
		$I_C=75\text{A}, V_{GE}=15\text{V}, T_J=125^\circ\text{C}$		1.95		
		$I_C=75\text{A}, V_{GE}=15\text{V}, T_J=150^\circ\text{C}$		2.05		
I_{CES}	Collector Leakage Current	$V_{CE}=650\text{V}, V_{GE}=0\text{V}, T_J=25^\circ\text{C}$			100	μA
		$V_{CE}=650\text{V}, V_{GE}=0\text{V}, T_J=150^\circ\text{C}$			5	mA
I_{GES}	Gate Leakage Current	$V_{CE}=0\text{V}, V_{GE}=\pm 20\text{V}, T_J=25^\circ\text{C}$	-200		200	nA
g_{fs}	Transconductance	$V_{CE}=20\text{V}, I_C=75\text{A}, T_J=25^\circ\text{C}$		70		S
Q_G	Gate Charge	$V_{CE}=400\text{V}, I_C=75\text{A}, V_{GE}=15\text{V}$		0.17		μC
C_{ies}	Input Capacitance	$V_{CE}=25\text{V}, V_{GE}=0\text{V}, f=1\text{MHz}$		5400		pF
C_{oes}	Output Capacitance			330		
C_{res}	Reverse Transfer Capacitance			40		
$t_{d(on)}$	Turn on Delay Time	$V_{CC}=400\text{V}, I_C=75\text{A}$ $R_G=7.5\Omega,$ $V_{GE}=15\text{V},$ Inductive Load	$T_J=25^\circ\text{C}$	28		ns
			$T_J=125^\circ\text{C}$	28		ns
			$T_J=150^\circ\text{C}$	28		ns
t_r	Rise Time		$T_J=25^\circ\text{C}$	24		ns
			$T_J=125^\circ\text{C}$	26		ns
			$T_J=150^\circ\text{C}$	28		ns
$t_{d(off)}$	Turn off Delay Time	$T_J=25^\circ\text{C}$	152		ns	
		$T_J=125^\circ\text{C}$	168		ns	
		$T_J=150^\circ\text{C}$	172		ns	
t_f	Fall Time	$T_J=25^\circ\text{C}$	20		ns	
		$T_J=125^\circ\text{C}$	26		ns	
		$T_J=150^\circ\text{C}$	28		ns	
E_{on}	Turn on Energy	$V_{CC}=400\text{V}, I_C=75\text{A}$ $R_G=7.5\Omega,$ $V_{GE}=15\text{V},$ Inductive Load	$T_J=125^\circ\text{C}$	1.7		mJ
			$T_J=150^\circ\text{C}$	1.9		mJ
E_{off}	Turn off Energy		$T_J=125^\circ\text{C}$	1.35		mJ
			$T_J=150^\circ\text{C}$	1.4		mJ

Anti-Parallel Diode

ELECTRICAL CHARACTERISTICS ($T_C = 25^\circ\text{C}$ unless otherwise specified)

Symbol	Parameter/Test Conditions		Min.	Typ.	Max.	Unit
V_F	Forward Voltage	$I_F=75\text{A}, V_{GE}=0\text{V}, T_J=25^\circ\text{C}$		1.9	2.4	V
		$I_F=75\text{A}, V_{GE}=0\text{V}, T_J=125^\circ\text{C}$		1.7		
		$I_F=75\text{A}, V_{GE}=0\text{V}, T_J=150^\circ\text{C}$		1.65		
t_{rr}	Reverse Recovery Time	$I_F=75\text{A}, V_R=400\text{V}$ $dI_F/dt=-1950\text{A}/\mu\text{s}$ $T_J=150^\circ\text{C}$		162		ns
I_{RRM}	Max. Reverse Recovery Current			62		A
Q_{RR}	Reverse Recovery Charge			5		μC
E_{rec}	Reverse Recovery Energy			1.4		mJ

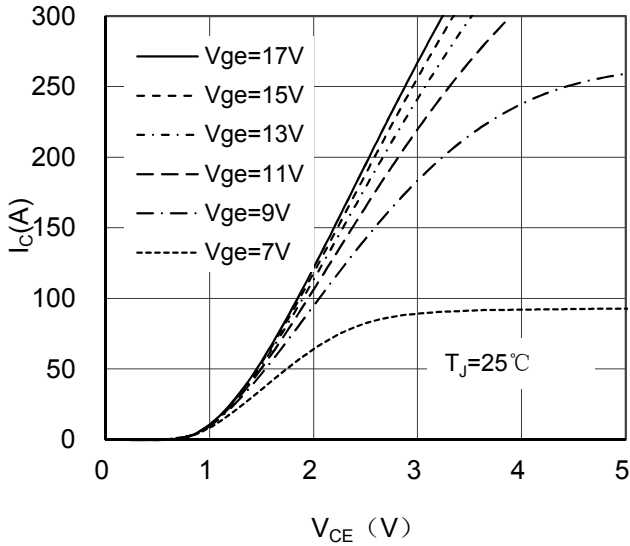

Figure 1. Typical Output Characteristics

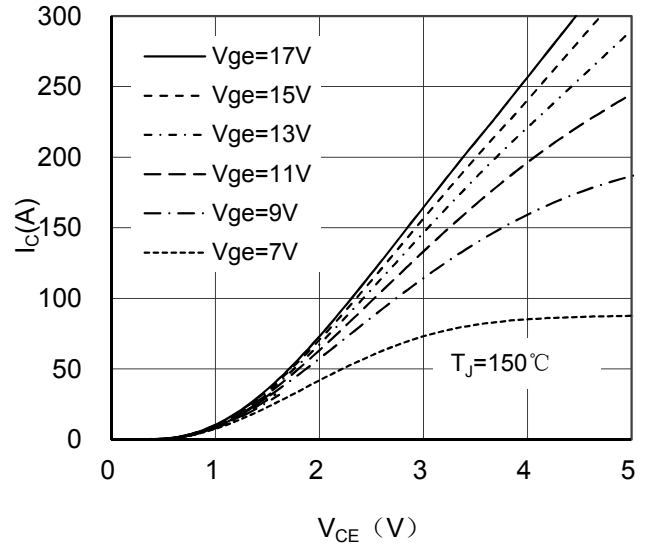

Figure 2. Typical Output Characteristics

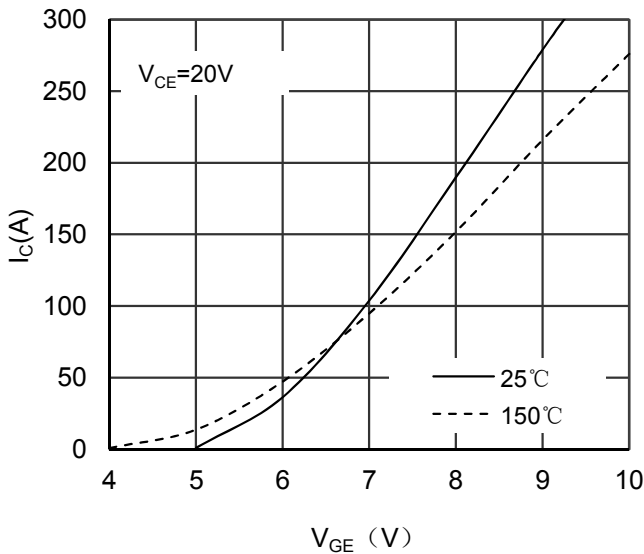

Figure 3. Typical Transfer characteristics

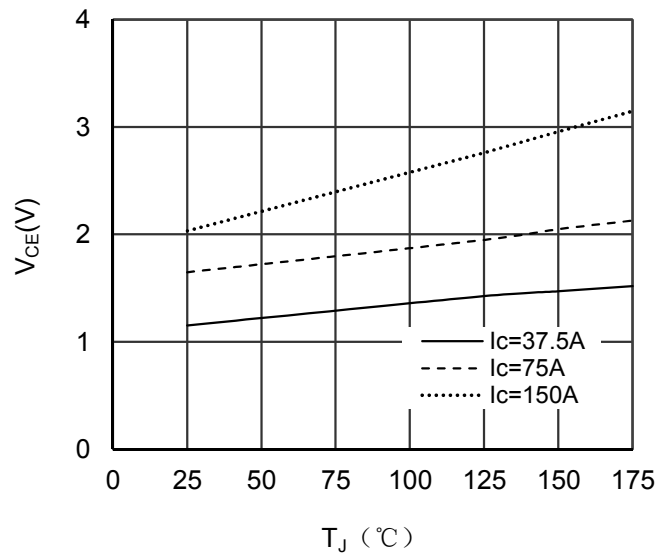

Figure 4. Collector-Emitter Voltage vs Junction temperature

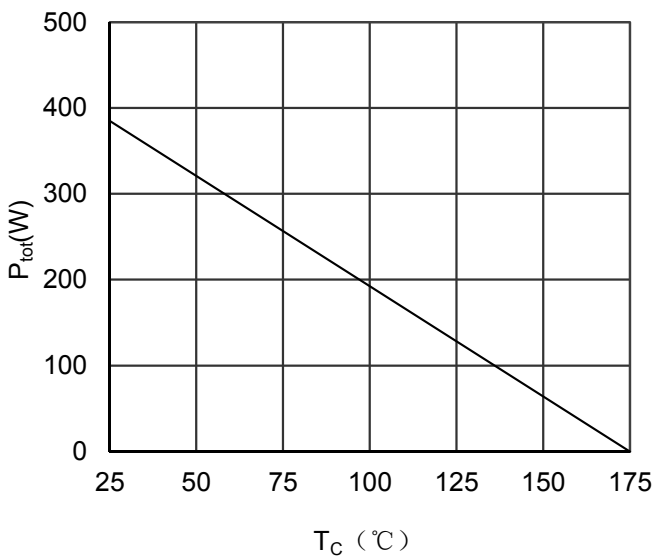

Figure 5. Power Dissipation vs Case temperature

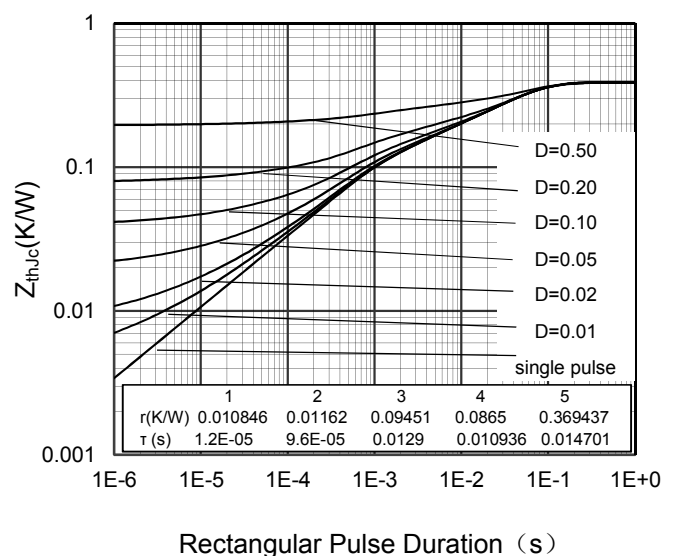

Figure 6. IGBT Transient Thermal Impedance

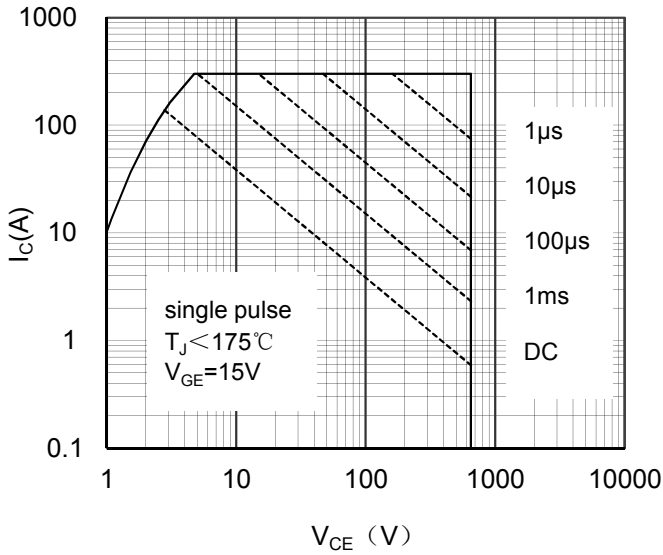

Figure 7. Forward Biased Safe Operating Area

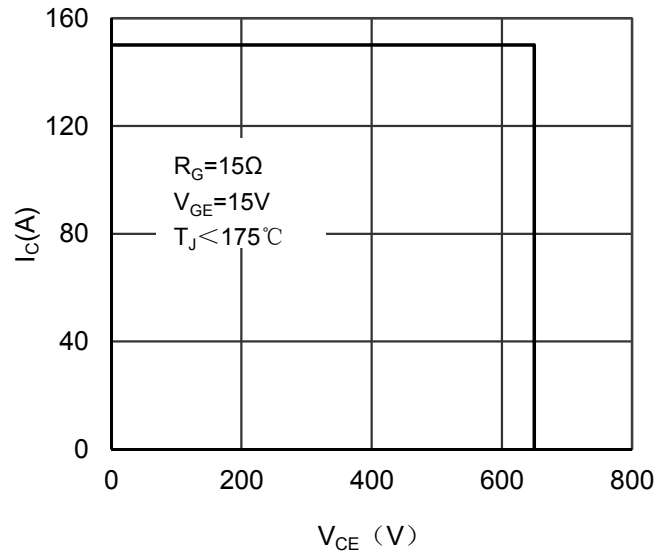

Figure 8. Reverse Biased Safe Operating Area

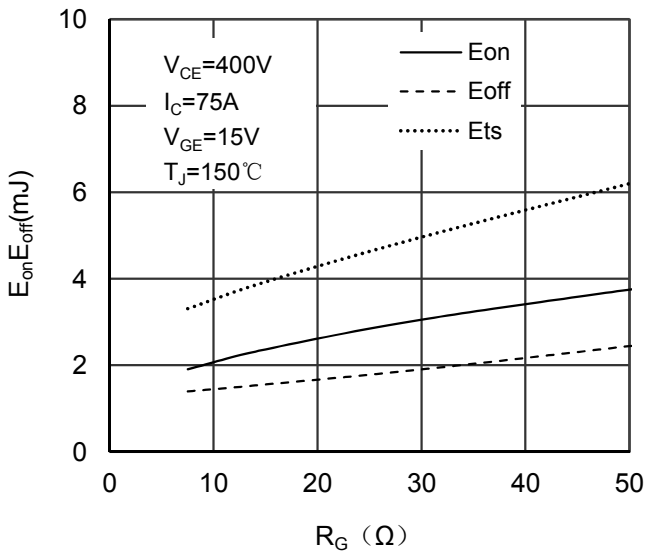

Figure 9. Switching Energy vs Gate Resistor Diode

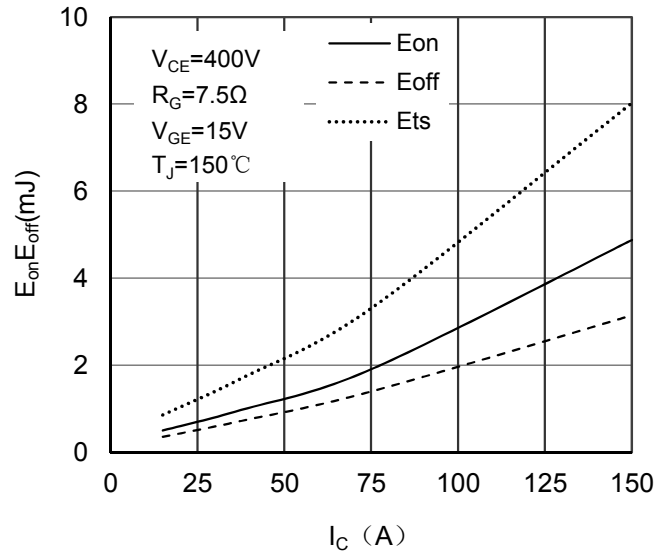

Figure 10. Switching Energy vs Collector Current

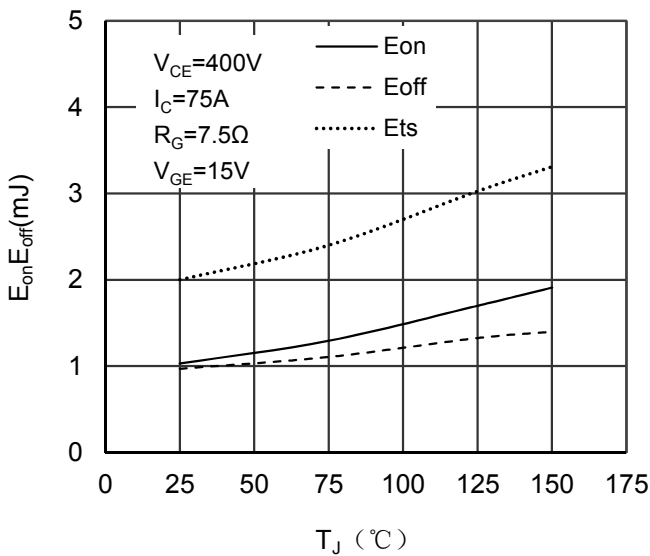

Figure 11. Switching Energy vs Junction temperature

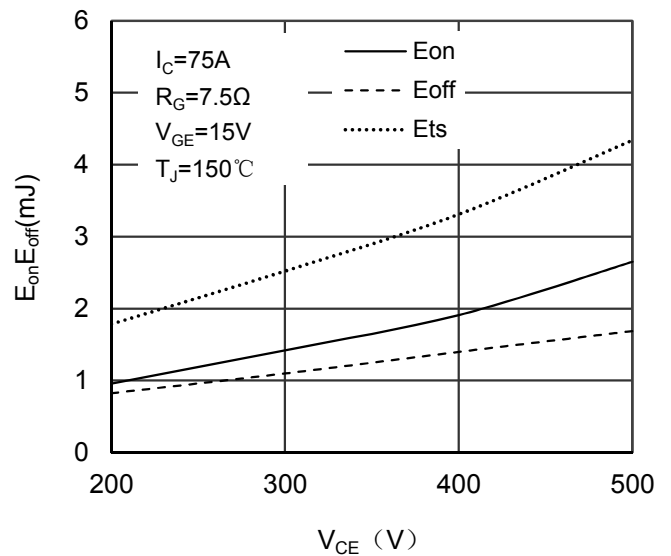

Figure 12. Switching Energy vs Collector-Emitter Voltage

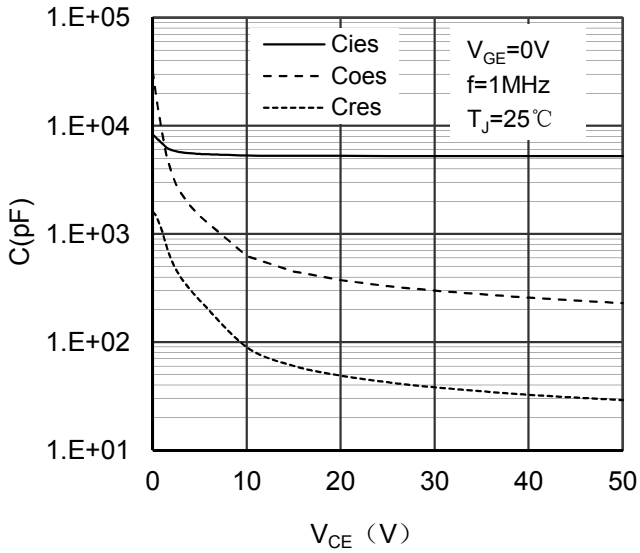

Figure 13. Typical capacitance

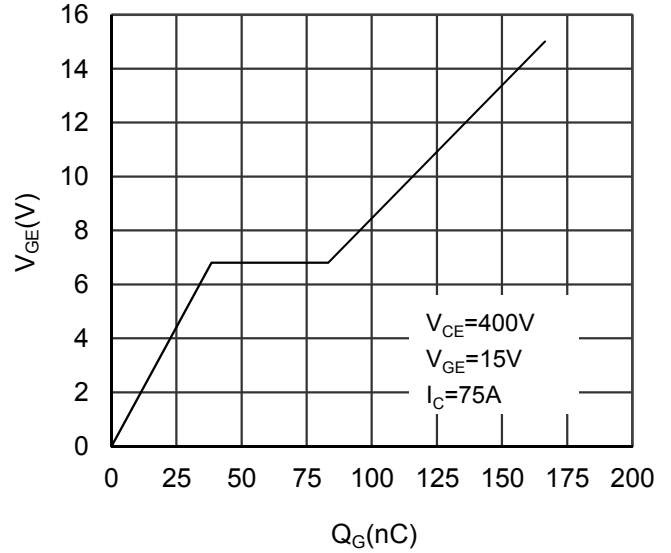

Figure 14. Typical Gate Charge

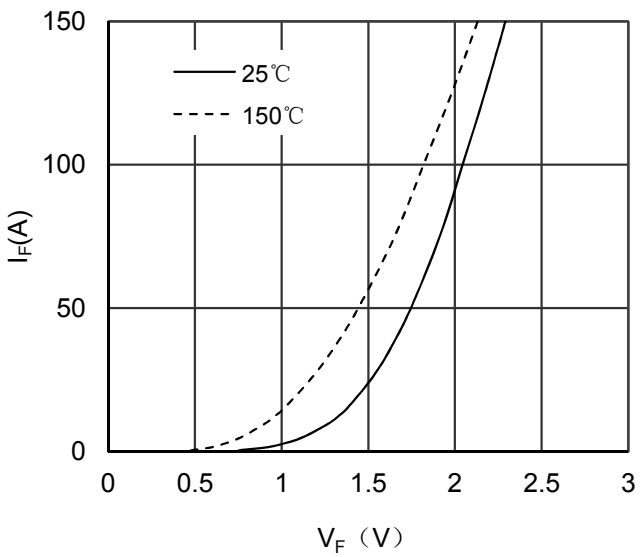

Figure 15. Diode Forward Characteristics

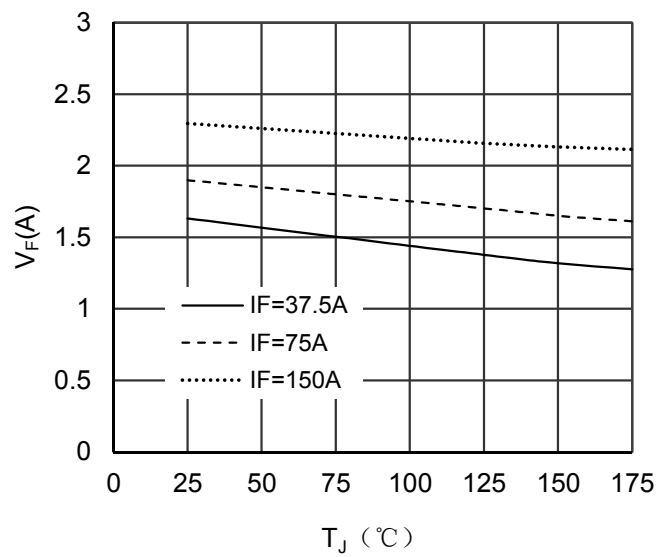

Figure 16. Forward Voltage vs Junction temperature Diode

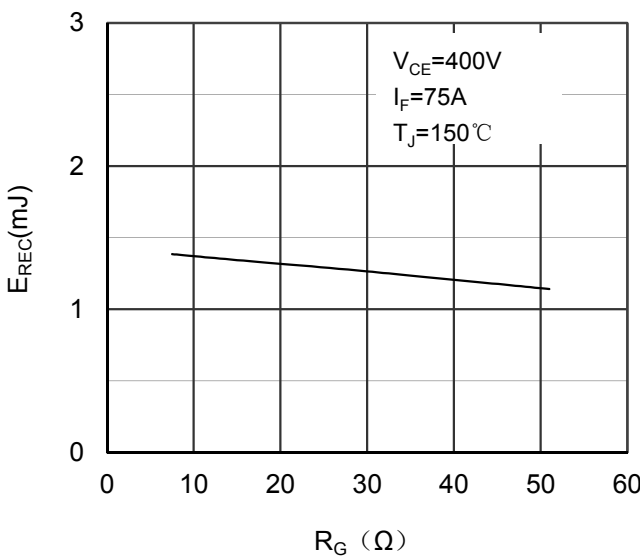

Figure 17. Switching Energy vs Gate Resistor Diode

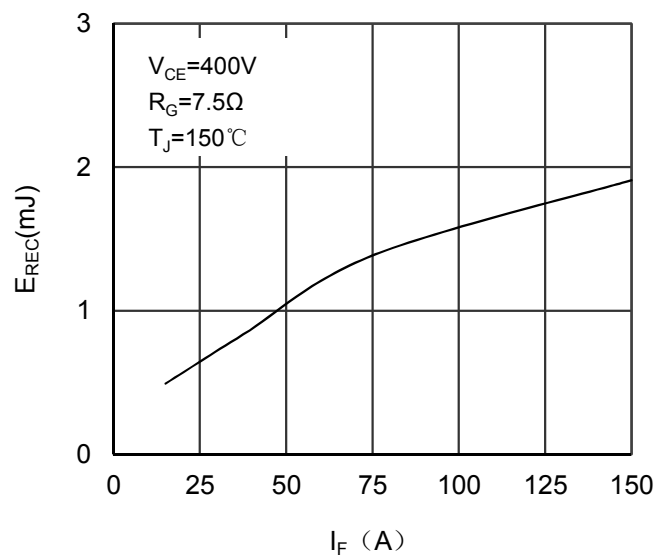

Figure 18. Switching Energy vs Forward Current Diode

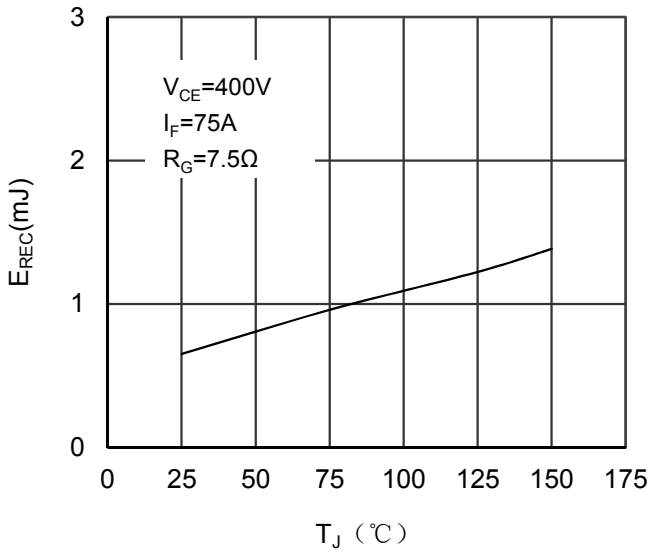

Figure 19. Switching Energy vs Junction temperature

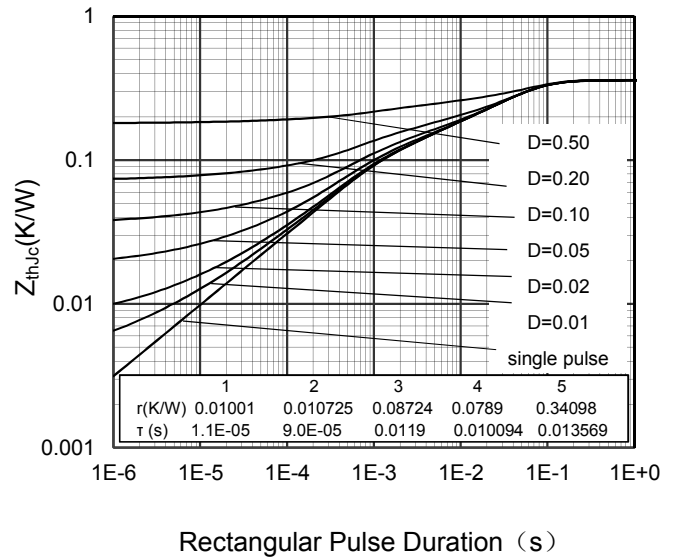
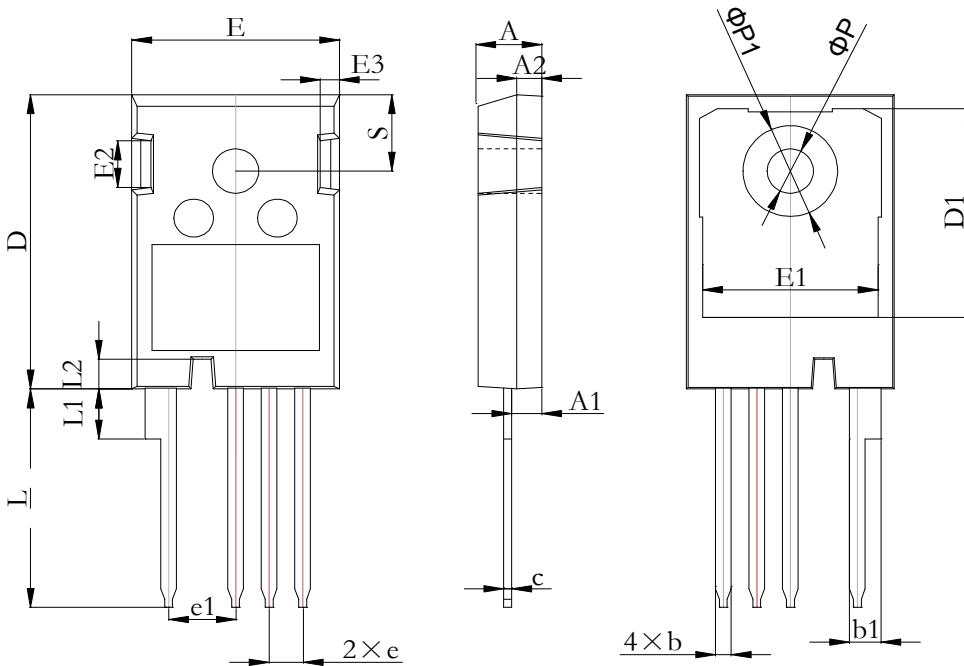

Figure 20. Diode Transient Thermal Impedance Diode



Symbol	Min	Nom	Max
A	4.83	5.02	5.21
A1	2.29	2.42	2.54
A2	1.91	2.04	2.16
b	1.07	1.34	1.60
b1	2.39	2.67	2.94
c	0.55	0.62	0.68
e	2.54BSC		
e1	5.08BSC		
E	15.75	15.94	16.13
E1	12.38	12.91	13.43
E2	3.68	4.39	5.10
E3	1.00	1.14	1.90
D	23.30	23.45	23.60
D1	16.25	17.10	17.65
L	17.31	17.57	17.82
L1	3.97	4.17	4.37
L2	2.35	2.50	2.65
ΦP	3.51	3.58	3.65
ΦP1	-	-	7.18
S	6.04	6.17	6.30

Dimensions in (mm)
Figure 21. Package Outline